

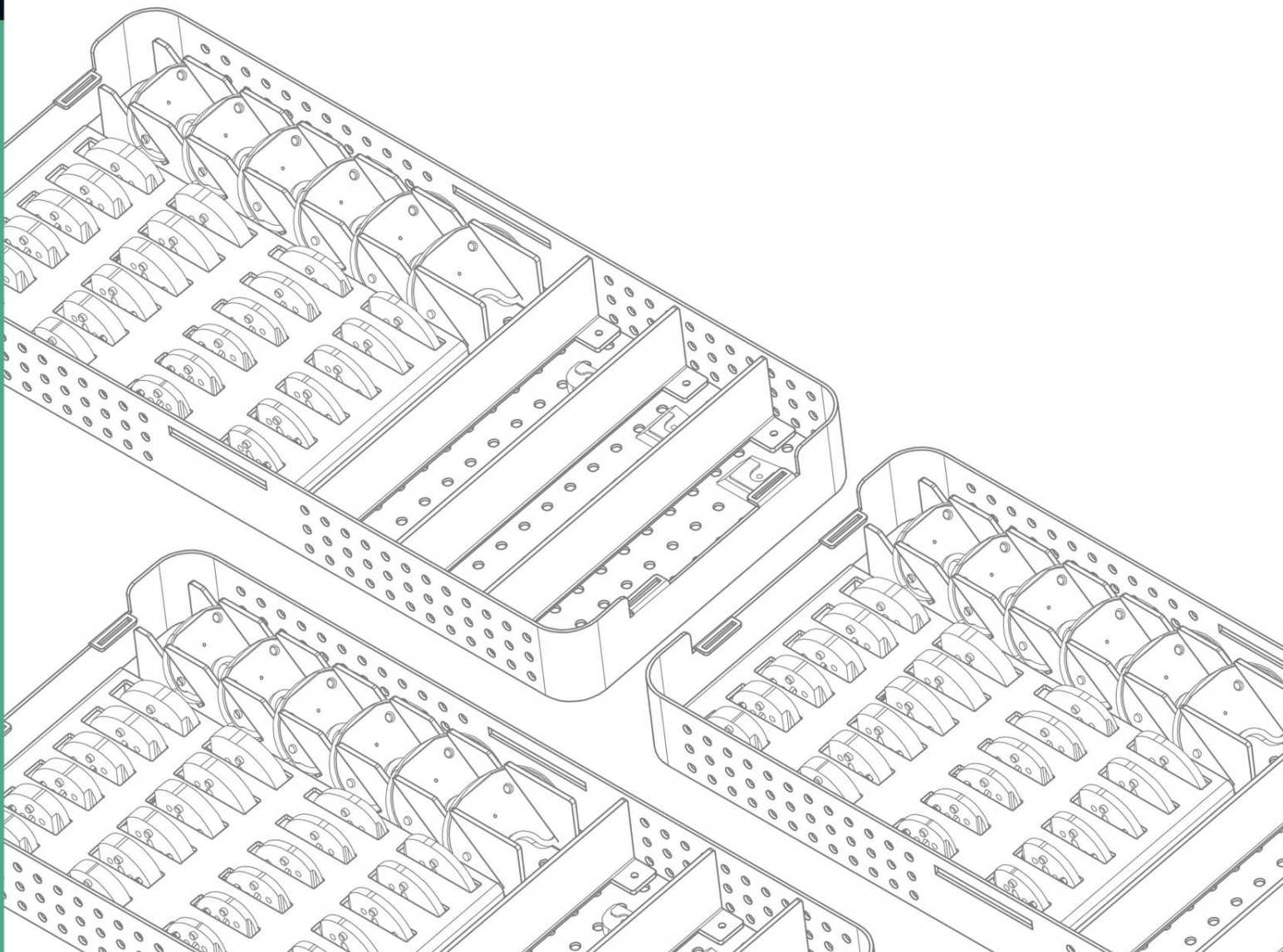











KNEE Instrument Disassembly/Assembly and Specific Cleaning Instructions











Content

Clinical Cleaning – Graphical Symbols	1
Femoral IM Alignment Guide.....	1
EX. 9304-2101.....	1
Patellar Reamer Stopper.....	2
EX. 9401-4205.....	2
Patellar Resection Clamp.....	3
EX. 9401-5302-RB.....	3
Tibial EM Alignment Guide.....	4
EX. 9403-2104-RA.....	4
EX. 9403-2108.....	6
EX. 9404-2101.....	8
Tibial IM Alignment Guide	10
EX. 9403-2103.....	10
EX. 9403-2103-RA.....	10
EX. 9403-2310.....	10

Clinical Cleaning – Graphical Symbols

Pictogram	Title Description	Standard/Ref. No.
	Direction in general Direction of the motion or force (push, pull and bend)	ISO 14617-2 / 241
	Alternative directions in general Two-way direction of the motion or force.	ISO 14617-2 / 241
	Limited rectilinear motion To indicate limited rectilinear motion.	ISO 7000 / IEC 60417 / 0001
	Direction of continuous rotation To indicate that a control, or an object by means of a control, can be moved in a clockwise rotary motion.	ISO 7000 / IEC 60417 / 0004
	Limited rotation To indicate limited rotary motion in a clockwise direction.	ISO 7000 / IEC 60417 / 0006
	Rotation in two directions To indicate that a control, or an object by means of a control, can be moved in a clockwise and anticlockwise rotation.	ISO 7000 / IEC 60417 / 0005
	Rotational movement clockwise To indicate clockwise rotational movement with the axis of rotation parallel to the direction of production.	ISO 7000 / IEC 60417 / 0978
	Rotational movement anticlockwise To indicate anticlockwise rotational movement with the axis of rotation parallel to the direction of production.	ISO 7000 / IEC 60417 / 0976
	Lock; tighten To indicate the function of locking or clamping two machine parts together, or location of a machine element in a fixed position.	ISO 7000 / IEC 60417 / 0018
	Unlock; unclamp To indicate the function of releasing two machine elements locked or clamped together, or the releasing of a machine element from a fixed position.	ISO 7000 / IEC 60417 / 0019
	Limited rotation and return To indicate limited successive motion in clockwise and anticlockwise directions	ISO 7000 / IEC 60417 / 0007
	Caution Caution or Instructions for Use.	ISO 15223-1 / 5.4.4 EN 980 / 5.11

	Tap water flush To identify an open water tap or connection or the control to open up the water supply.	ISO 7000 / IEC 60417 / 5574
	Spraying Spraying use syringes, pipettes and/or water jet.	ISO 7000 / IEC 60417 / 0073
	Rotary brush Use the Pipe brush or Test tube brush with threading or twisting motion.	ISO 7000 / IEC 60417 / 0307
	Locking To identify on a control that a function is locked or to show the locked status.	ISO 7000 / IEC 60417 / 5569
	Unlocking To identify on a control that a function is not locked or to show the unlocked status.	ISO 7000 / IEC 60417 / 5570
	Manufacturer Indicate the medical device manufacturer, as defined in EU Directives 90/385/EEC, 93/42/EEC and 98/79/EC.	ISO 15223-1 / 5.1.1 EN 980 / 5.12
	Authorized representative in the European Community Indicate the authorized representative in the European Community.	ISO 15223-1 / 5.1.2 EN 980 / 5.13
	Success To identify the control to acknowledge affirmatively and to indicate the status of acknowledgement, or to indicate the successful status.	ISO 7000 / IEC 60417 / 6334A
	Failure To indicate the status of negative acknowledgement, or to indicate the failed status.	ISO 7000 / IEC 60417 / 6335B



FOR MORE DETAILED CLEANING PROCEDURES PLEASE REFER TO UOC-UM-UN-00029 (MT50867), REPROCESSING INSTRUCTIONS FOR REUSABLE SURGICAL INSTRUMENTS.



United Orthopedic Corporation
No. 57, Park Ave 2, Science Park,
Hsinchu, 300, Taiwan.
TEL: +886-3-5773351
FAX: +886-3-5777156
E-MAIL: service@unitedorthopedic.com



mdi Europa GmbH
Langenhagener Straße 71
30855 Langenhagen, Germany
TEL: +49-511-3908 9530
FAX: +49-511-3908 9539

Femoral IM Alignment Guide

EX. 9304-2101

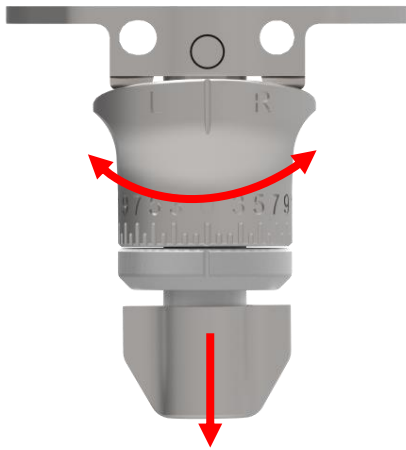

Cleaning

1

2

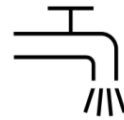

1

Beware the gap.

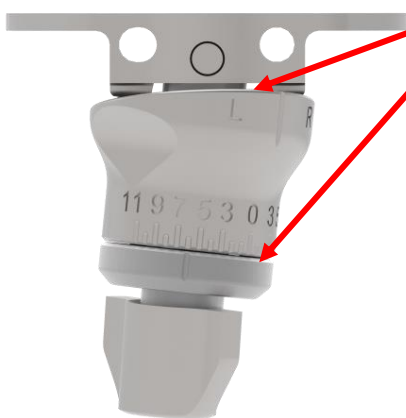

2

Assembly after cleaning

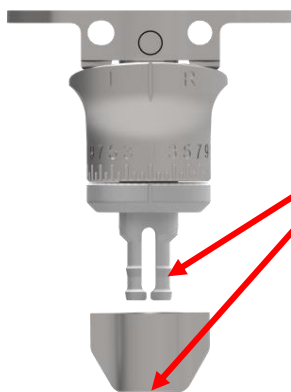

Patellar Reamer Stopper

EX. 9401-4205

Disassembly & Assembly

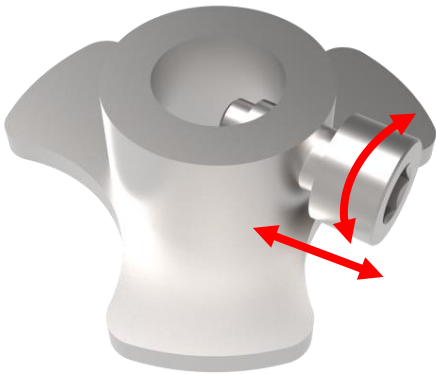

Cleaning

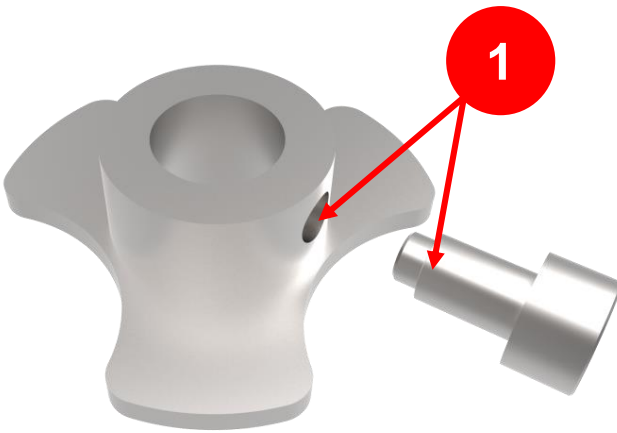

Patellar Resection Clamp

EX. 9401-5302-RB



Pull back to unlock

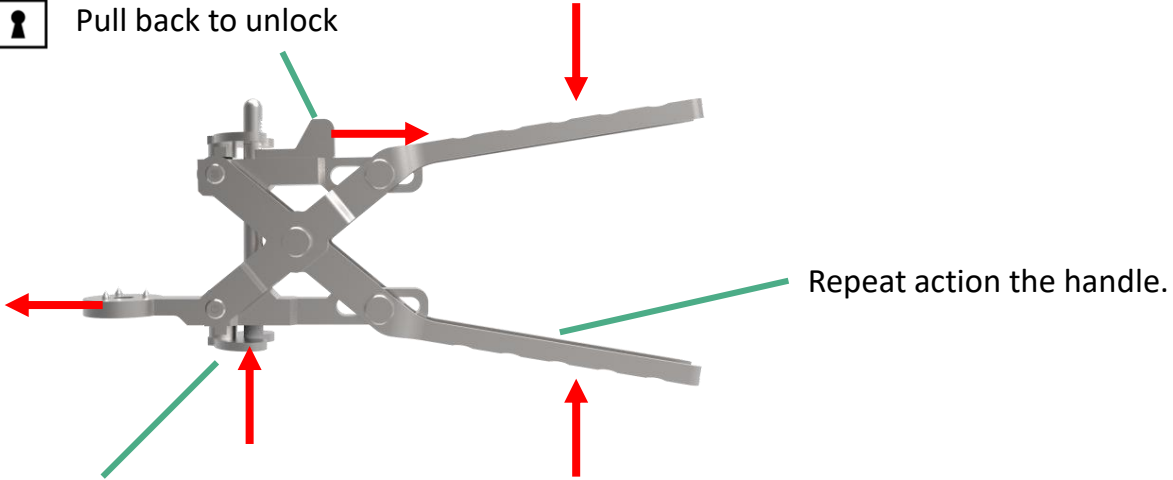

Push to unlock the front part

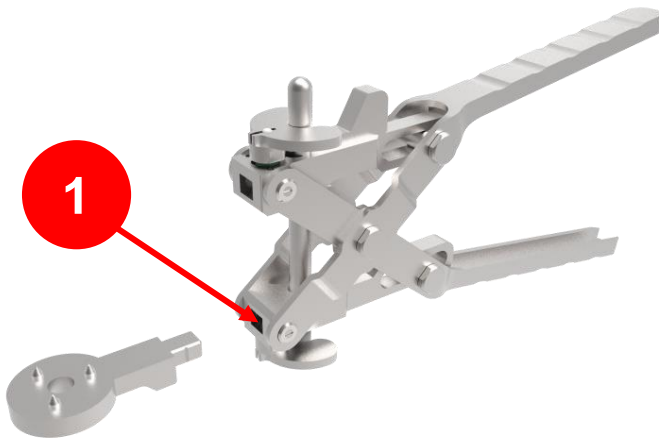

Cleaning

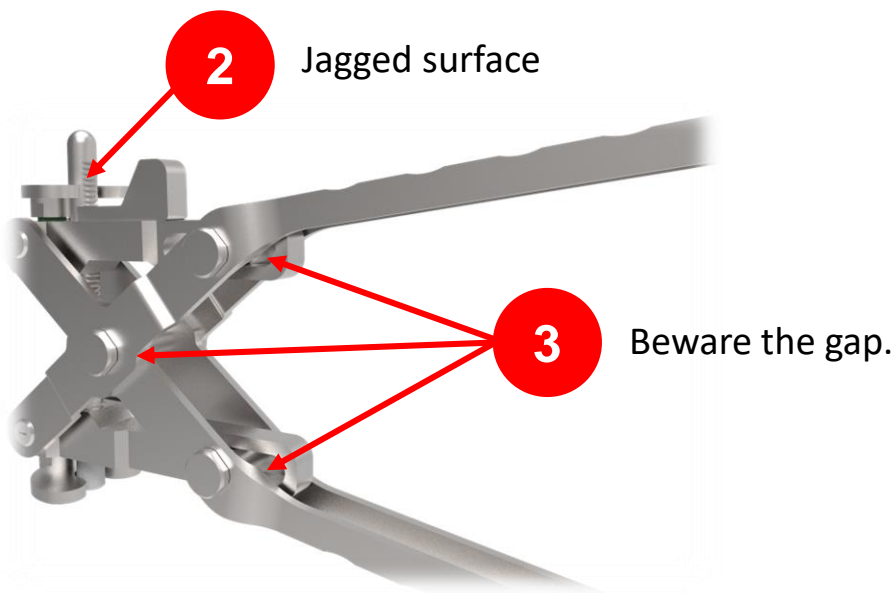

Flush and spray small gaps.

Tibial EM Alignment Guide

EX. 9403-2104-RA

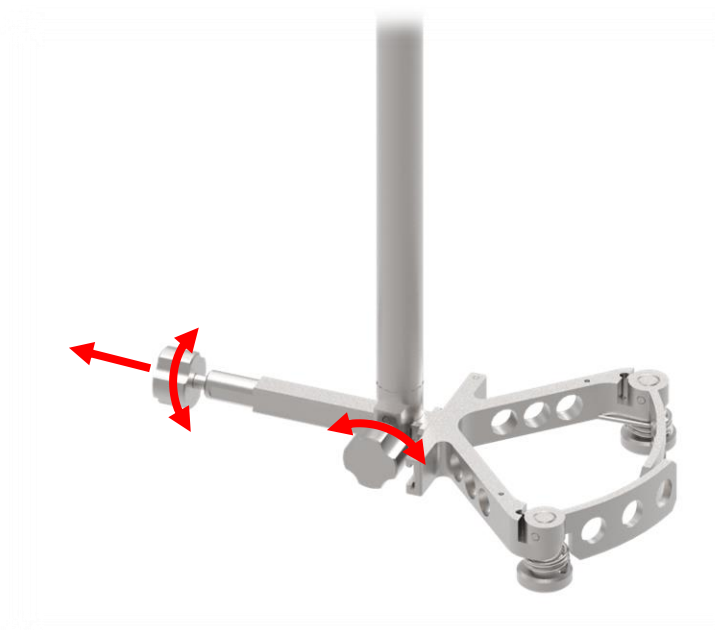
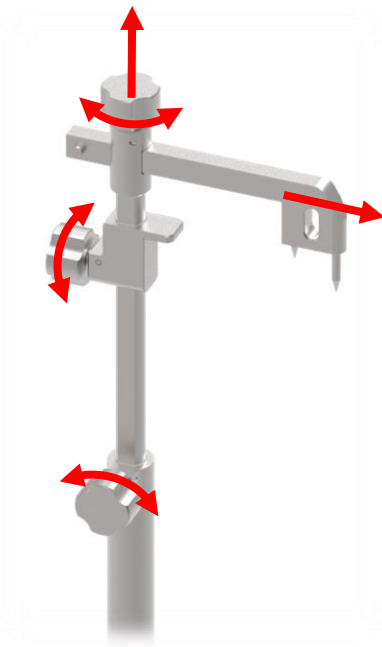

Disassembly **Assembly**

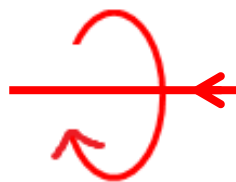
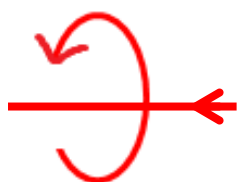

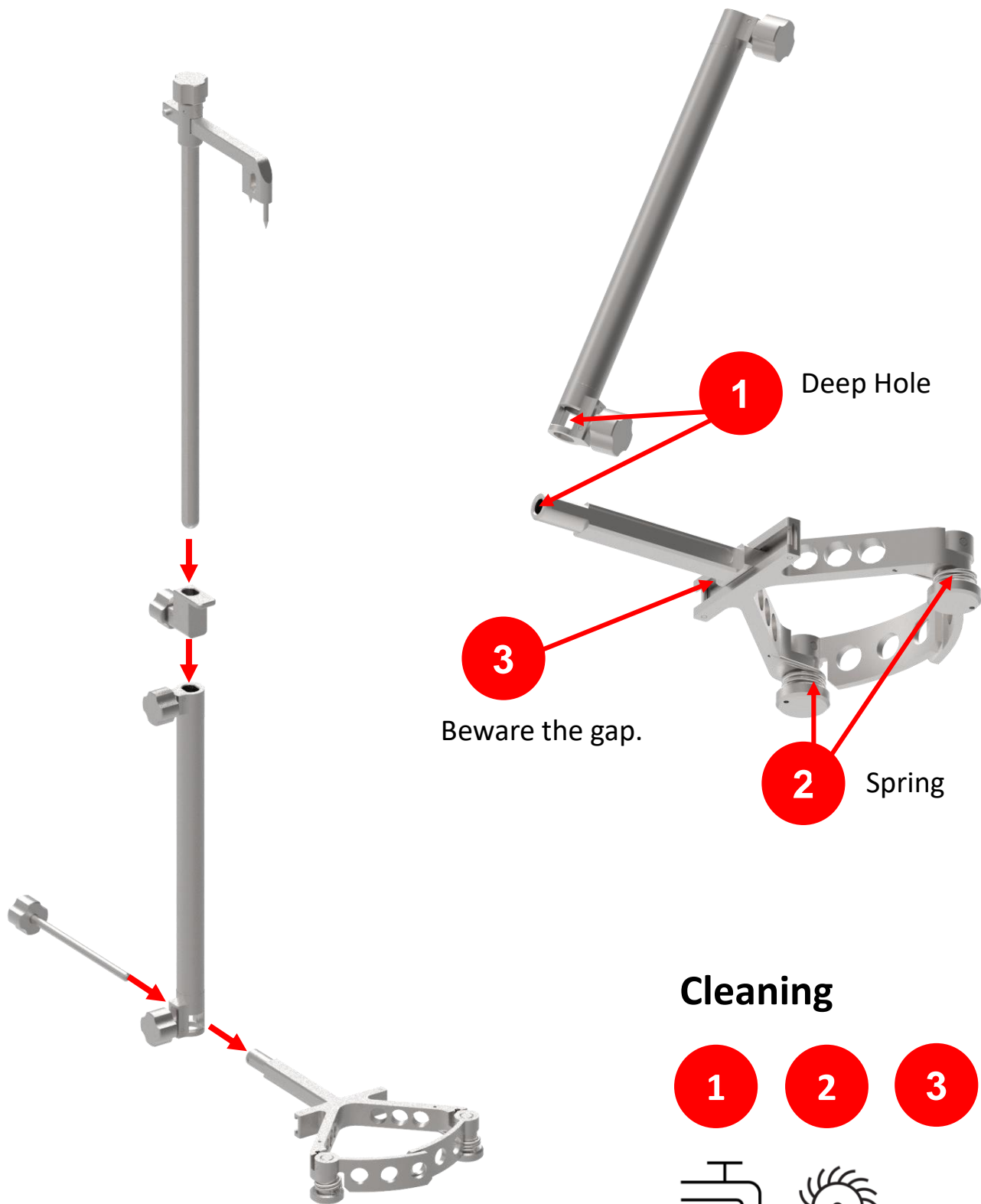

Tibial EM Alignment Guide

EX. 9403-2108

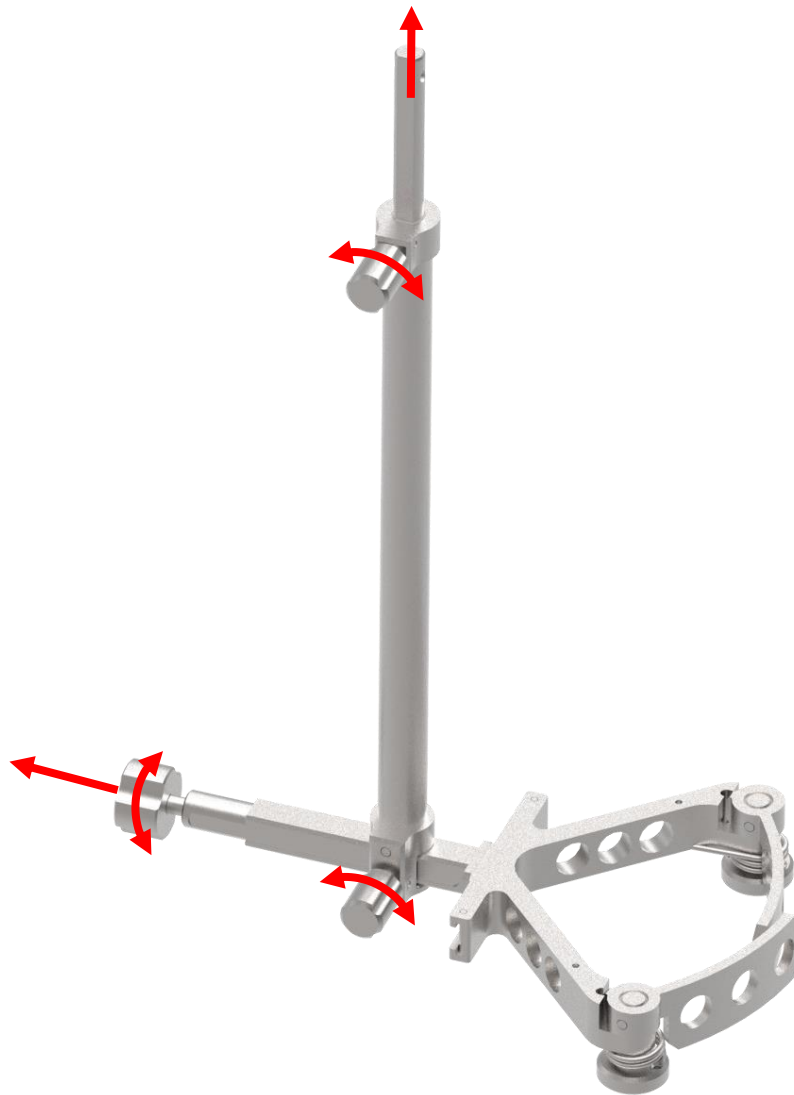

Disassembly **Assembly**

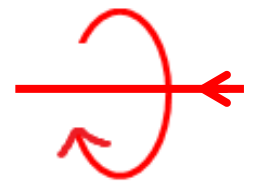
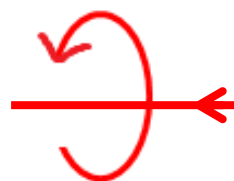

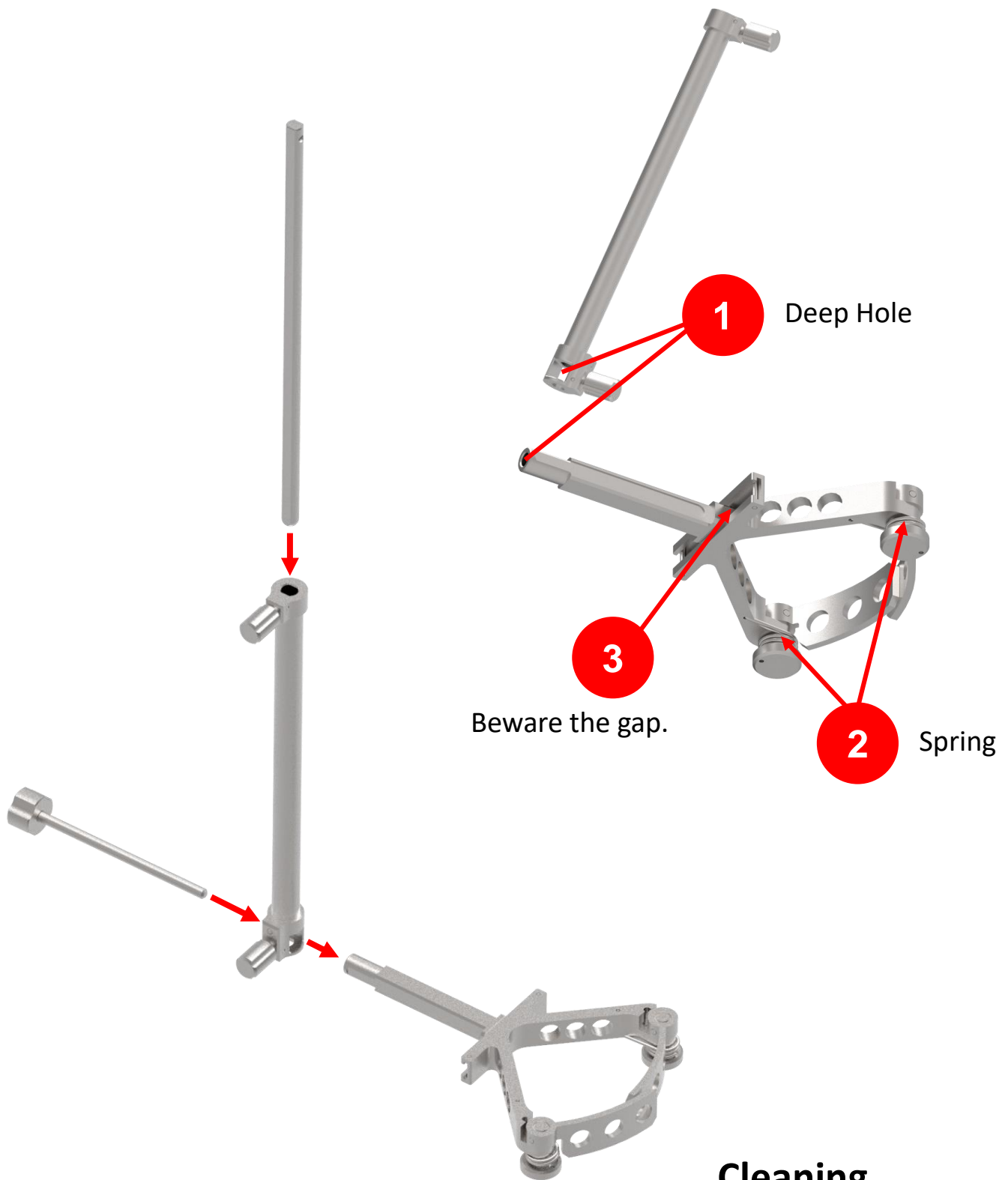

Cleaning



Tibial EM Alignment Guide

EX. 9404-2101

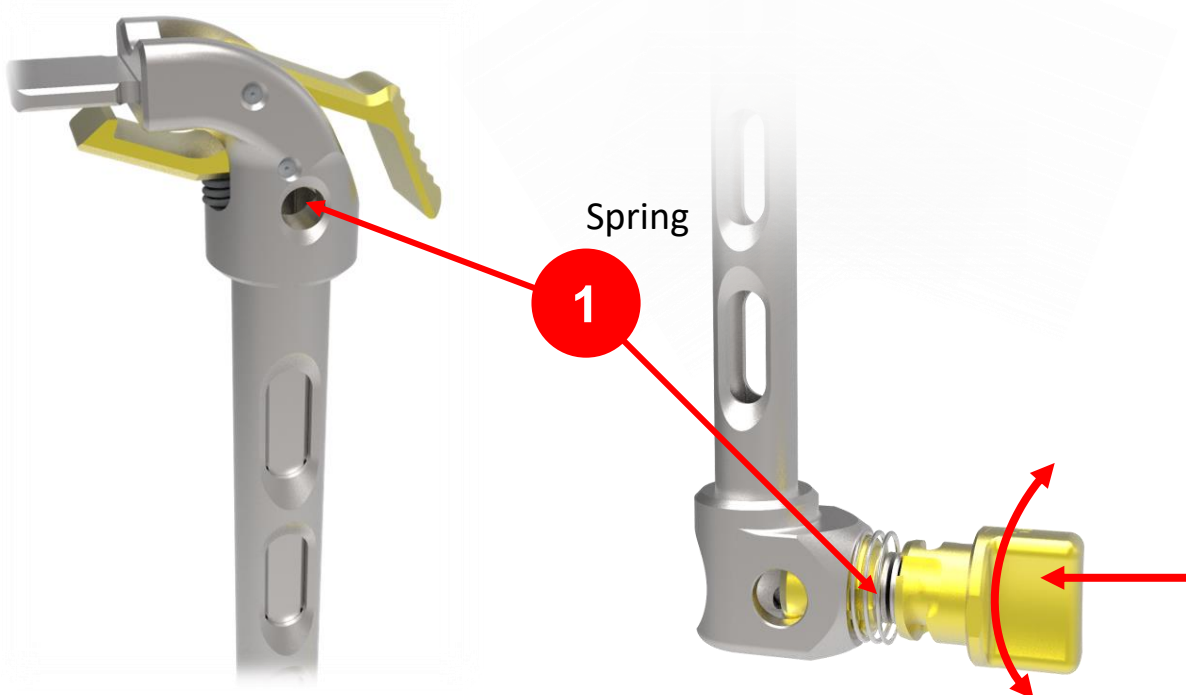
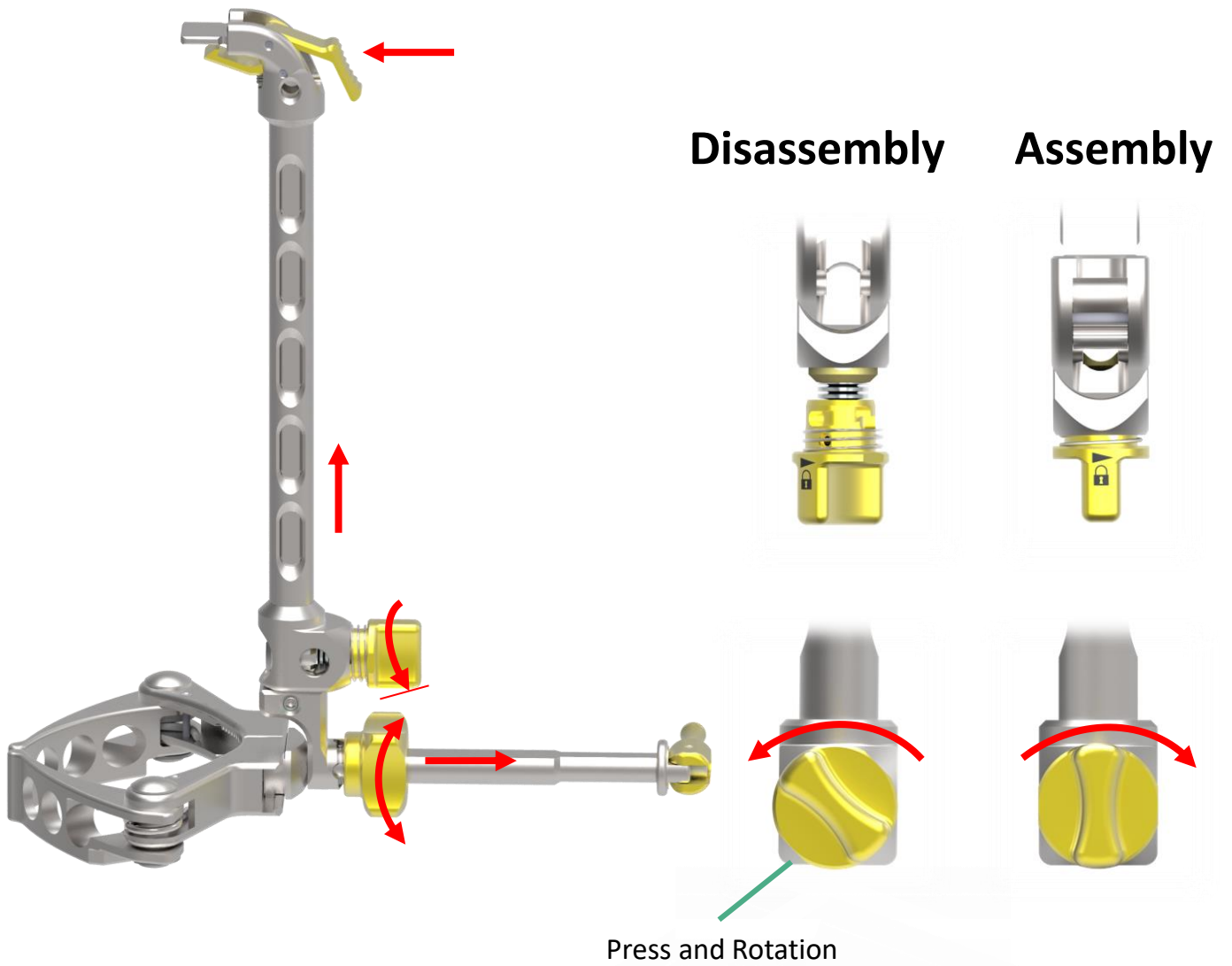



Cleaning

- 1
- 2
- 3

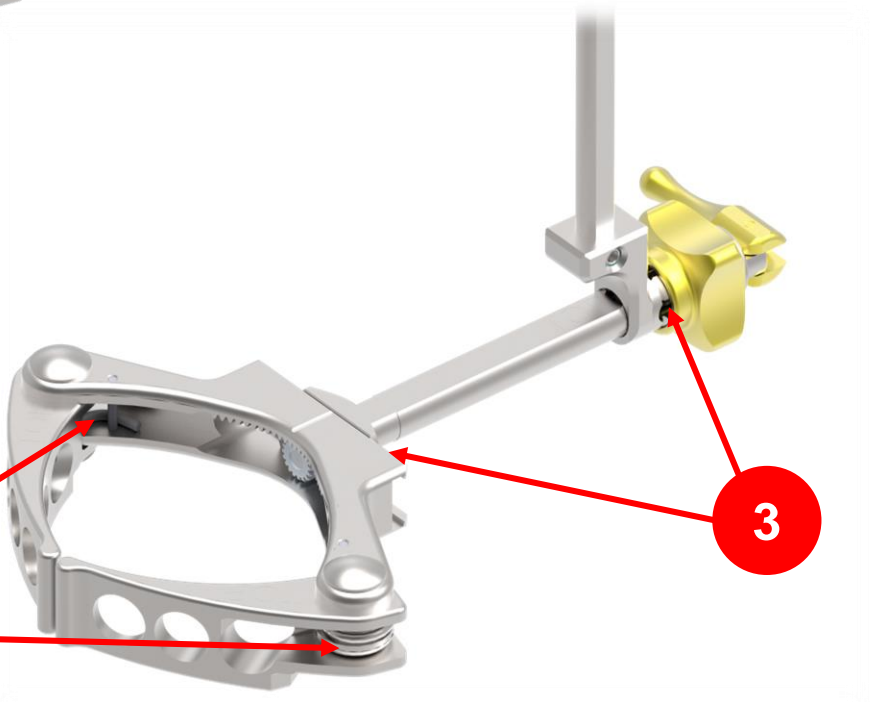
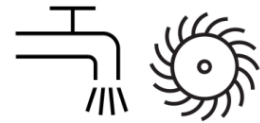

Spring

Tibial IM Alignment Guide

EX. 9403-2103
EX. 9403-2103-RA
EX. 9403-2310

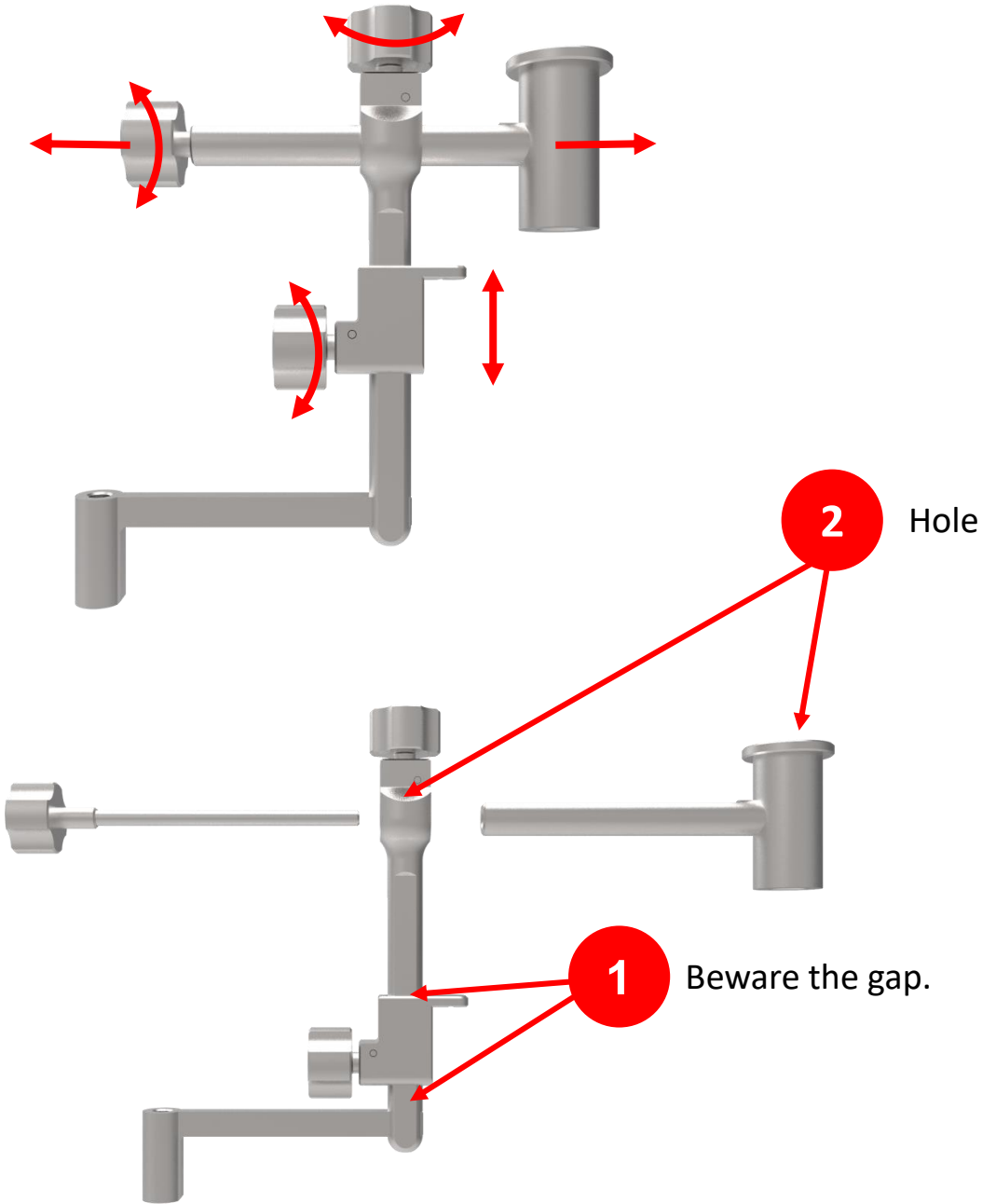

Disassembly

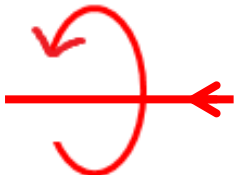

Assembly

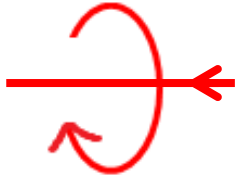

Cleaning

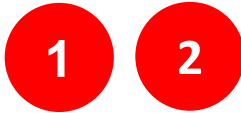

Please note that this Surgical Technique Guide has been authored in the English language. Any translations into other languages have not been reviewed or approved by United Orthopedic Corporation and their accuracy cannot be confirmed. Any translated guide should be reviewed carefully prior to use and questions regarding a Surgical Technique Guide should be directed to United Orthopedic Corporation at unitedorthopedic.com/contact

The CE mark is valid only if it is also printed on the product label.

